

DC INVERTER Heat Pump

User Manual

(Carel controller)



Attention

Thank you for choosing our product, we shall be more than glad to service you. For you to better operate this product and to prevent accidents due to misoperation, please read carefully this user manual before carrying out any installation or operation, also please pay special attention to the warning, prohibition and attention instructions. We are continuously supplementing and upgrading this user manual to better service for you!

Contents

Part 1. Before use.....	2
1. Attentions.....	2
2. Installation.....	4
● Heat pump installation location and attentions.....	4
● Installation diagram and tips.....	5
● Pre-start up.....	8
Part 2. Use.....	9
● Buttons function.....	9
● Operating panel display.....	10
● Parameters query and setting.....	15
Part 3. Maintenance and repairing.....	16
● Daily maintenance.....	16
● Error code and repairing.....	18
● Other problem and repairing.....	23
Warranty	24

Part 1. Before Use

1. Attentions



Warning



Caution



Prohibition



This appliance is not intended for use by persons, including children, with reduced physical, sensory or mental capabilities, or lack of experience and knowledge, unless they have been given supervision or instruction concerning use of the appliance by a person responsible for their safety. Children should be supervised to ensure that they do not play with the appliance.



Be sure to read this manual before use.

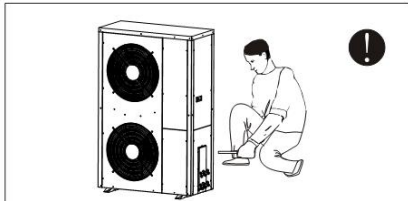

Be sure to read this manual before use. The installation, dismantling and maintenance of the unit must be performed by qualified personnel. It is forbidden to do any changes to the structure of the unit. Otherwise injury of person or unit damage might happen.

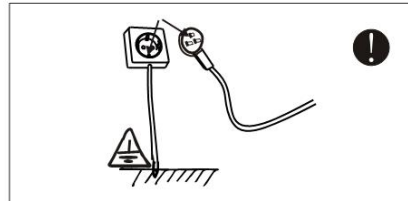

The power supply to the unit must be grounded.

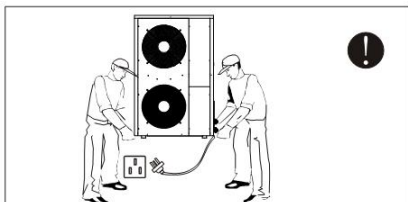

Make sure the power supply to the heat pump unit is off before any operations are done on the unit. When the power cord gets looser or is damaged, always get a qualified person to fix it.

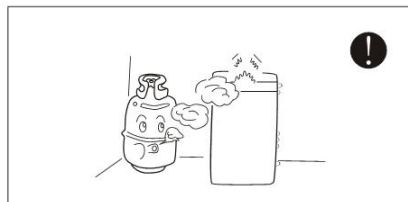

Keep the unit away from the combustible or corrosive environment.

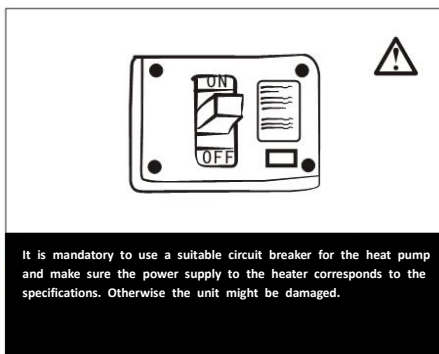
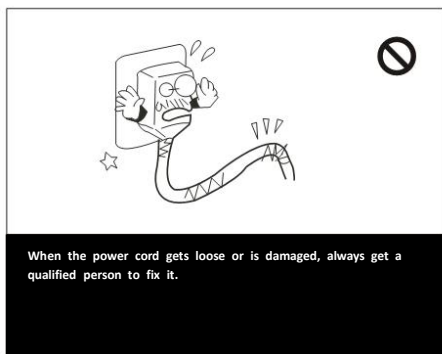
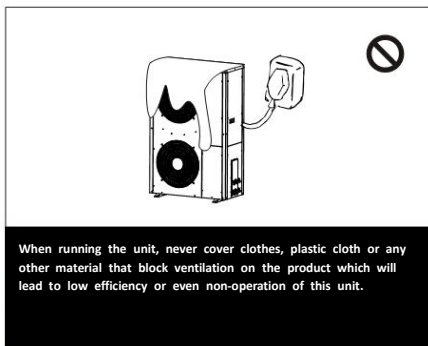
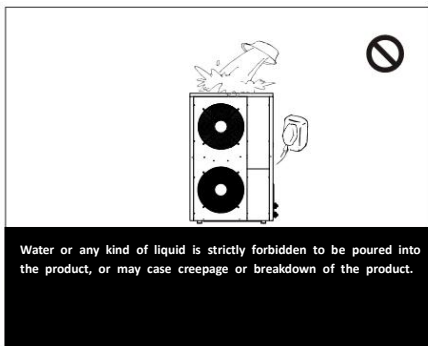
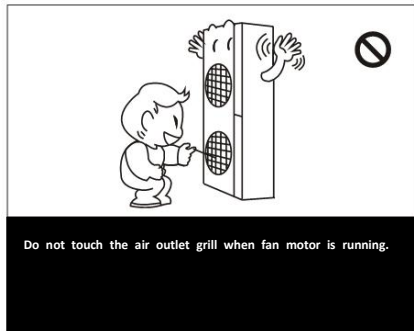
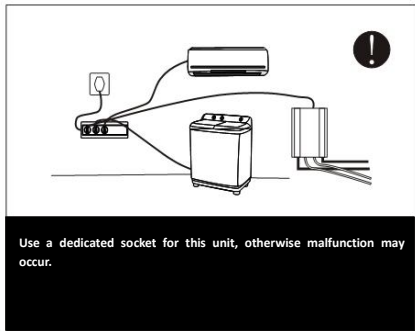

2. Installation

(1) Heat pump installation location and attentions

- * Heat pump is not allowed to be installed in the place where combustible gas may leaks.
- * Heat pump is not allowed to be installed in the place where there is oil or corrosion gas released.
- * Heat pump should be installed in a open space, and good ventilating.
- * Heat pump each side to wall or barrel should be keep certain distance, air outlet to barrel distance should $\geq 2m$, air inlet distance to wall or barrel $\geq 0.5m$, bottom distance to ground $\geq 0.5m$, other side distance should be enough for installation or repairing.
- * Heat pump should be installed on concrete basic or steel bracket, and anti-shock pad should be put between heat pump and basic or bracket. Then use expansion bolt to fix heat pump on bracket.
- * Water drainage pipe and ditch should be set around heat pump and water pipes and water tank. When testing or repairing, maybe need drain plenty of water, and when heat pump is working, there are some condensed water flow down.

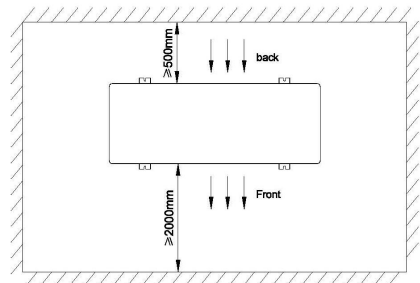
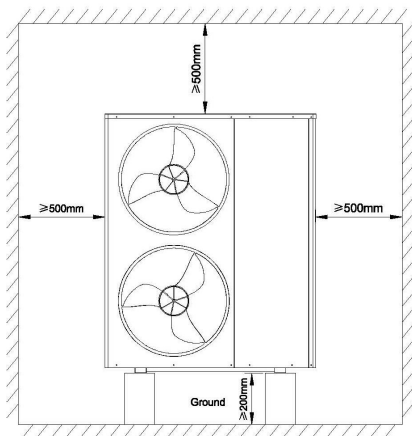

(2) Installation diagram and tips (for reference only, installation shall be based on actual project demand)



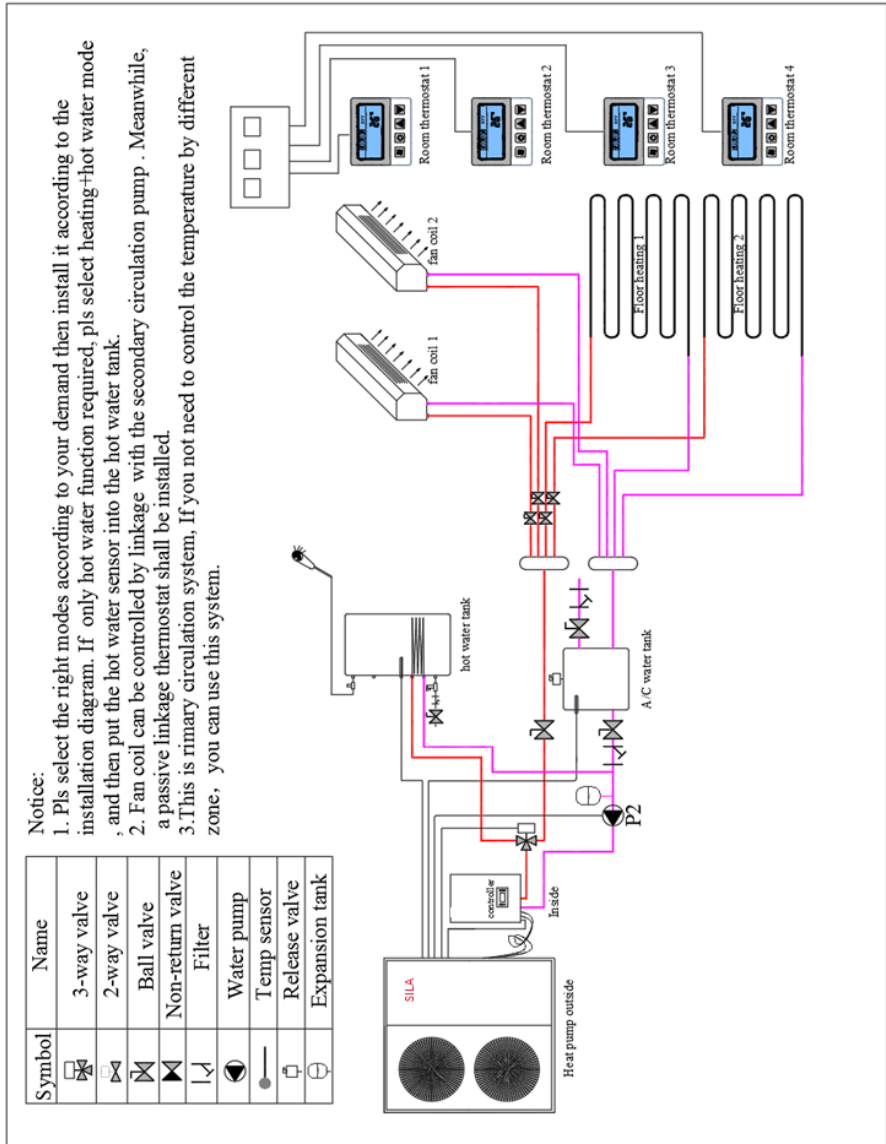





Primary circulation system



Secondary circulation system

Notice:

1. Pls select the right modes according to your demand then install it according to the installation diagram. If only hot water function required, pls select heating+hot water mode , and then put the hot water sensor into the hot water tank.
2. Two-way valve and BV valve are optional for installation. Only If you need to control the temperature by different zone, then pls install both.
3. Fan coil can be controlled by linkage with the secondary circulation pump . Meanwhile, a passive linkage thermostat shall be installed.

Symbol	Name
	3-way valve
	2-way valve
	Ball valve
	Non-return valve
	Filter
	Water pump
	Temp sensor
	Release valve
	Expansion tank

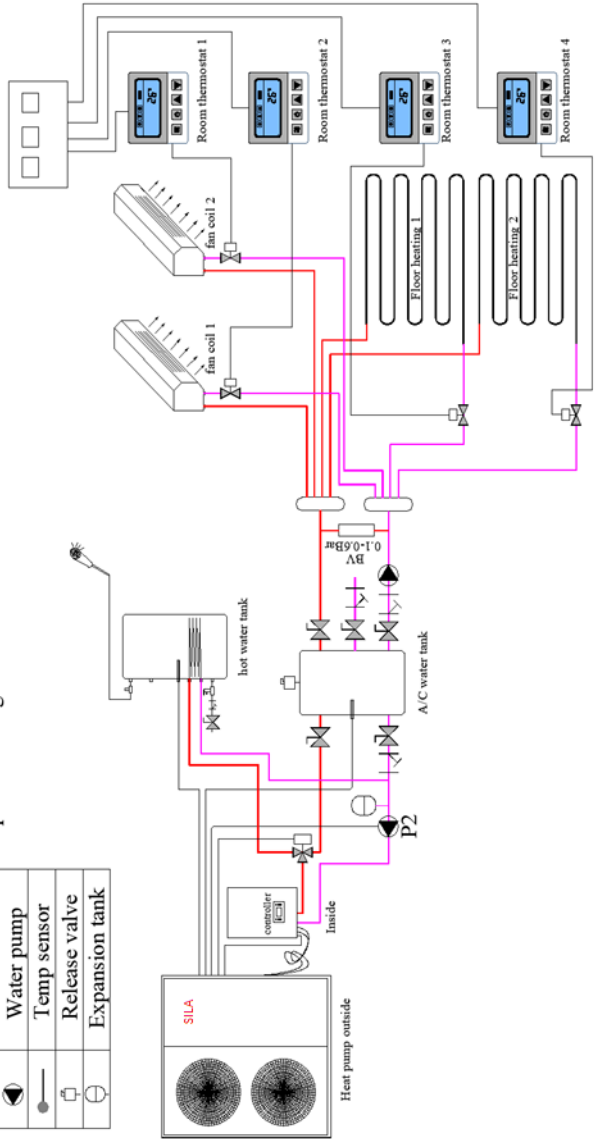

Tips for installation related to the water pipe part:

- Install a valve at the highest point of each water circulations for releasing air from water system.
- A Y-shape filter is very important in front of circulating water pump of heat pump.
- If more pieces heat pump installed in one water pipe system, the connection of these heat pumps can't be in series, only can be in parallel or independent.

(3) Pre-start up

① Checking before pre-start up

- Check if the water pipe are connected well and if there is any leakage. The water supply valve are open.
- Make sure the water flow is enough and meet the demand of the heat pump selected and water flow smoothly without air . In cold area, pls make sure that the water flow is without freezing
- Check if the power cable is connected well and properly grounded.
- Check if fan blade is blocked by the fixing plate of fan blade and fan blade protecting grill.
- Check if the tank has been filled with water or enough water volume that can meet the demand of heat pump running



If everything above is OK, the unit can start up. If any of them fails, please improve it.

② Pre-start up







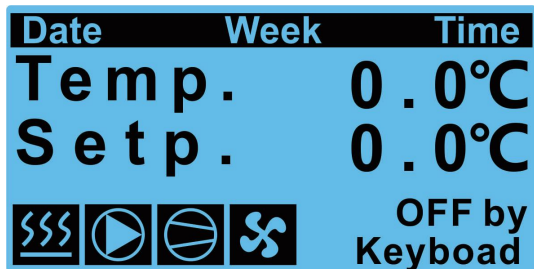



- After check completely and confirm no problem for installation, the unit can be power to start up .
- After connect power supply, heat pump delay 3mins to start. Check carefully is there is some abnormal noise or vibration or if the working current is normal or if water temp increasing is normal.
- After the unit is working properly for 10 minutes without any problem, then the pre-start up is usefully completed. If not, pls refer to Service and Maintenance Chapter to solve the problem.

Part 2. Use





Main interface



The icon:



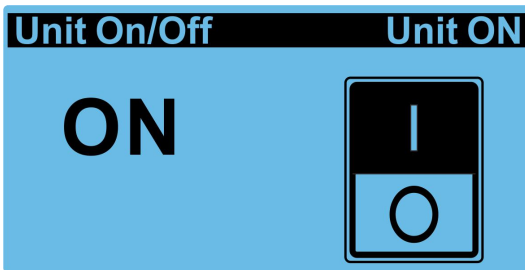

- 1, Heating mode 
- 2, Pump 
- 3, Compressor 
- 4, Fan 
- 5, Defrost 
- 6, Cooling mode 
- 7, Alarm 
- 8, Exit 
- 9, Menu & Confirm 
- 10, Select 
- 11, Factory parameters 

1、 Turn on/off

Press  to access menu , press  to select Unit On/Off, then press  to confirm. Press  to turn on/off, and press  to confirm:



2、 Mode switching (Heating, Cooling, Hot water, Hot water+cooling, Hot water+heat)

Press  to access menu, press  button to select User Mask, then press  to confirm. Press  Button to switch mode, and press  to confirm, Egc. Mode switching&Temperature setting.

Attention: Only switch mode when the unit is turn off

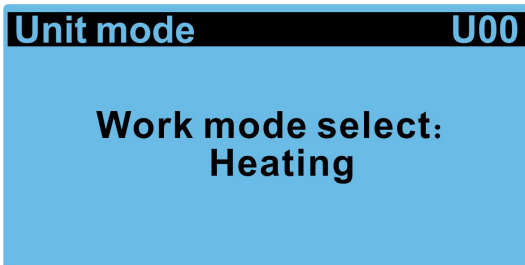
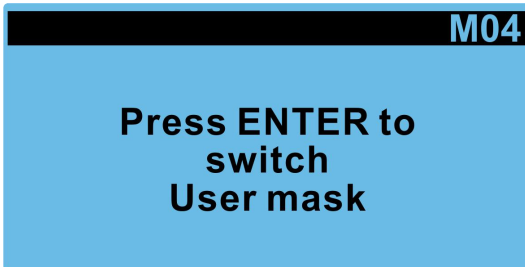

The setting temperature interface is as follows:

Setpoint U01	
Heating setp.:	
Cooling setp.:	
Hotwater setp.:	

Setpoint U02	
Hot water set:	°C
Temp.diff.:	°C
Stop temp.diff.:	°C

Setpoint U02	
Cooling and heat mode	
Temp. diff:	°C
Stop temp. diff.:	°C

Setpoint U03	
PID management	
Kp:	
Integral:	
Differential:	

Pump control U04	
Pump work:	Normal



User configure U05	
Fan mode:	Daytime
Enable heater:	Disable
Enable chassis/crack heater:	Disable

Heater control U06	
Comp. delay:	0 min
Ext.temp. setp:	0.0°C

Pump control U07	
Delta temp. set:	0.0°C

User configure U08	
Auto start:	Disable

3、TimeZone/CLOCK

Press  to access menu, press $\uparrow\downarrow$ button to select TimeZone/CLOCK, then press  to confirm, Press $\uparrow\downarrow$ Button to change the setting, and press  to confirm.

M03

Press ENTER to
switch
TIMEZONE/CLOCK

Date/time change

Date:
Hour:
Day:

Clock mng. C102

Timezone on off : Enable
Timezone setpoint : Enable

Clock mng. C103

	ON	OFF
Mon.:		
Tue.:		
Wed.:		
Thu.:		

Clock mng. C104

	ON	OFF
Fri.:		
Sat.:		
Sun.:		

Clock mng. C105

Timezone1:
Cooling temp.: °C
Heating temp.: °C
Tank temp.: °C

Clock mng. C106

Timezone2:
Cooling temp.: °C
Heating temp.: °C
Tank temp.: °C



Clock mng. C107

Timezone3:
Cooling temp.: °C
Heating temp.: °C
Tank temp.: °C

Clock mng. C108

Timezone4:
Cooling temp.: °C
Heating temp.: °C
Tank temp.: °C

4、Input/Output

Press  to access menu, press \uparrow / \downarrow button to select I/O mask, then press  to confirm, Press \uparrow / \downarrow Button to see the I/O, E.g.c Water temperature/Pressure/Frequency and so on.

M02

Press ENTER to
switch
I/O mask

Input/output Sn01

Inlet temp. : °C
Outlet temp. : °C
Ext temp. : °C

Input/output Sn02

Disch. gas temp.: °C
Suct. gas temp.: °C
Disch. press.: °C

Input/output Sn03

Suct. press.: bar
Coil temp.: °C

Input/output Sn05

Digit input status

1 Flow switch:
2 Remote switch:
3 Termin switch:
5 Phase switch:

Input/output Sn03

B8 Hotwater temp.: °C

Input/output Sn06

Digit output status

1 fan high speed:
2 Fan low speed:
3 4 way valve:

Input/output Sn07

Digit output status

4 Pump:
5 Three valve:
6 Crank heater:

Input/output Sn08

Digit output status

8 Chassis heater:
10 Heater:

Input/output Sn09

Analog output status

Y1 Fan output
Y3 Pump output

User setting parameter:

Parameter Name		Initial Value
Unit mode		Heating
Heating setp.		45°C
Cooling setp.		12°C
Hotwater setp.		50°C
Temp. diff.		5°C
Stop temp. diff.		0°C
Cool and heat mode Temp. diff.		5°C
Stop temp. diff.		2°C
Kp		5°C
Integral		200s
Differential		0s
Pump work		Demand
Pump Auto		Enable
Fan model		Daytime
Enable heater		Enable
Enable chassic/crack heater		Enable
Heater control-Comp. delay		60min
Heater control-Ext.temp.setp.		5°C
Pump control	Delta temp. set.	5°C
Auto start		Enable

Part 3. Maintenance and repairing

1、 Maintenance Tips

The heat pump unit is a highly automated equipment. The unit status check is carried out regularly during use. If the unit can be maintained and maintained for a long time and effectively, the unit's operational reliability and service life will be unexpectedly improved.

- 1、 Users should pay attention to the use and maintenance of this unit: all safety protection devices in the unit are set before leaving the factory, do not adjust by yourself;
- 2、 Always check whether the power supply and electrical system wiring of the unit is firm, whether the electrical components are malfunctioning, and if necessary, repair and replace them in time;
- 3、 Always check the water system's hydration, the water tank safety valve, the liquid level controller and the exhaust device to work properly, so as to avoid the air circulation into the system and reduce the water circulation, thus affecting the unit's heating capacity and unit operation reliability;
- 4、 The unit should be kept clean and dry and well ventilated. Regularly clean (1-2 months) air-side heat exchangers to maintain good heat transfer;
- 5、 Always check the operation of each component of the unit, check the oil pipe at the pipe joint and the gas valve, and ensure that the refrigerant of the unit is not leaking;
- 6、 Do not stack any debris around the unit to avoid blocking the air inlet and outlet. The unit should be clean and dry and well ventilated.
- 7、 If the downtime is long, the water in the unit piping should be drained, and the power supply should be cut off and the protective cover should be placed. When running again, check the system thoroughly before starting up;

- 8、 If the unit fails and the user cannot solve the problem, please inform the company's special maintenance department in order to send someone to repair it in time;

- 9、 The main unit condenser cleaning, the company recommends using a 50 ° C concentration of 15% hot oxalic acid to clean the condenser, start the host with a circulating water pump for 20 minutes, and finally rinse with tap water 3 times. (It is recommended to reserve a three-way interface when installing the pipe and seal one interface with a wire plug) in case of cleaning. Do not wash the condenser with a corrosive cleaning solution. The water tank needs to be removed after a period of use (usually two months, depending on local water quality).

2、 Error input and protection alarm

1、 Error list

AL001	Too many mem writings
AL002	Retain mem write error
AL003	Inlet probe error
AL004	Outlet probe error
AL005	Ambient probe error
AL006	Condenser coil temp
AL007	Water flow switch
AL008	Phase sequ.prot.alarm
AL009	Unit work hour warning
AL010	Pump work hour warning
AL011	Comp.work hour warning
AL012	Cond.fan work hourWarn
AL013	Low superheat - Vlv.A
AL014	Low superheat - Vlv.B
AL015	LOP - Vlv.A
AL016	LOP - Vlv.B
AL017	MOP - Vlv.A
AL018	MOP - Vlv.B
AL019	Motor error - Vlv.A
AL020	Motor error - Vlv.B
AL021	Low suct.temp. - Vlv.A
AL022	Low suct.temp. - Vlv.B
AL023	High condens.temp.EVD
AL024	Probe S1 error EVD
AL025	Probe S2 error EVD
AL026	Probe S3 error EVD
AL027	Probe S4 error EVD
AL028	Battery discharge EVD
AL029	EEPROM alarm EVD

AL030	Incomplete closing EVD
AL031	Emergency closing EVD
AL032	FW not compatible EVD
AL033	Config. error EVD
AL034	EVD Driver offline
AL035	BLDC-alarm:High startup DeltaP
AL036	BLDC-alarm:Compressor shut off
AL037	BLDC-alarm:Out of Envelope
AL038	BLDC-alarm:Starting fail wait
AL039	BLDC-alarm:Starting fail exceeded
AL040	BLDC-alarm:Low delta pressure
AL041	BLDC-alarm:High discharge gas temp
AL042	Envelope-alarm:High compressor ratio
AL043	Envelope-alarm:High discharge press.
AL044	Envelope-alarm:High current
AL045	Envelope-alarm:High suction pressure
AL046	Envelope-alarm:Low compressor ratio
AL047	Envelope-alarm:Low pressure diff.
AL048	Envelope-alarm:Low discharge pressure
AL049	Envelope-alarm:Low suction pressure
AL050	Envelope-alarm:High discharge temp.
AL051	Power+ alarm:01-Overcurrent
AL052	Power+ alarm:02-Motor overload
AL053	Power+ alarm:03-DCbus overvoltage
AL054	Power+ alarm:04-DCbus undervoltage
AL055	Power+ alarm:05-Drive overtemp.
AL056	Power+ alarm:06-Drive undertemp.
AL057	Power+ alarm:07-Overcurrent HW
AL058	Power+ alarm:08-Motor overtemp.
AL059	Power+ alarm:09-IGBT module error
AL060	Power+ alarm:10-CPU error
AL061	Power+ alarm:11-Parameter default

AL062	Power+ alarm:12-DCbus ripple
AL063	Power+ alarm:13-Data comm. Fault
AL064	Power+ alarm:14-Thermistor fault
AL065	Power+ alarm:15-Autotuning fault
AL066	Power+ alarm:16-Drive disabled
AL067	Power+ alarm:17-Motor phase fault
AL068	Power+ alarm:18-Internal fan fault
AL069	Power+ alarm:19-Speed fault
AL070	Power+ alarm:20-PFC module error
AL071	Power+ alarm:21-PFC overvoltage
AL072	Power+ alarm:22-PFC undervoltage
AL073	Power+ alarm:23-STO DetectionError
AL074	Power+ alarm:24-STO DetectionError
AL075	Power+ alarm:25-Ground fault
AL076	Power+ alarm:26-Internal error 1
AL077	Power+ alarm:27-Internal error 2
AL078	Power+ alarm:28-Drive overload
AL079	Power+ alarm:29-uC safety fault
AL080	Power+ alarm:98-Unexpected restart
AL081	Power+ alarm:99-Unexpected stop
AL082	Power+ safety alarm:01-Current meas.fault
AL083	Power+ safety alarm:02-Current unbalanced
AL084	Power+ safety alarm:03-Over current
AL085	Power+ safety alarm:04-STO alarm
AL086	Power+ safety alarm:05-STO hardware alarm
AL087	Power+ safety alarm:06-PowerSupply missing
AL088	Power+ safety alarm:07-HW fault cmd.buffer
AL089	Power+ safety alarm:08-HW fault heater c.
AL090	Power+ safety alarm:09-Data comm. Fault
AL091	Power+ safety alarm:10-Compr. stall detect
AL092	Power+ safety alarm:11-DCbus over current
AL093	Power+ safety alarm:12-HWF DCbus current

AL094	Power+ safety alarm:13-DCbus voltage
AL095	Power+ safety alarm:14-HWF DCbus voltage
AL096	Power+ safety alarm:15-Input voltage
AL097	Power+ safety alarm:16-HWF input voltage
AL098	Power+ safety alarm:17-DCbus power alarm
AL099	Power+ safety alarm:18-HWF power mismatch
AL100	Power+ safety alarm:19-NTC over temp.
AL101	Power+ safety alarm:20-NTC under temp.
AL102	Power+ safety alarm:21-NTC fault
AL103	Power+ safety alarm:22-HWF sync fault
AL104	Power+ safety alarm:23-Invalid parameter
AL105	Power+ safety alarm:24-FW fault
AL106	Power+ safety alarm:25-HW fault
AL107	Power+ safety alarm:26-reseved
AL108	Power+ safety alarm:27-reseved
AL109	Power+ safety alarm:28-reseved
AL110	Power+ safety alarm:29-reseved
AL111	Power+ safety alarm:30-reseved
AL112	Power+ safety alarm:31-reseved
AL113	Power+ safety alarm:32-reseved
AL114	Power+ alarm:Power+ offline
AL115	EEV alarm:Low superheat
AL116	EEV alarm:LOP
AL117	EEV alarm:MOP
AL118	EEV alarm:High condens.temp.
AL119	EEV alarm:Low suction temp.
AL120	EEV alarm:Motor error
AL121	EEV alarm:Self Tuning
AL122	EEV alarm:Emergency closing
AL123	EEV alarm:Temperature delta
AL124	EEV alarm:Pressure delta
AL125	EEV alarm:Param.range error

AL126	EEV alarm:ServicePosit% err
AL127	EEV alarm:ValveID pin error
AL128	Low press alarm
AL129	High press alarm
AL130	Disc.temp.probe error
AL131	Suct.temp.probe error
AL132	Disc.press.probe error
AL133	Suct.press.probe error
AL134	Tank temp.probe error
AL135	EVI SuctT.probe error
AL136	EVI SuctP.probe error
AL137	Flow switch alarm
AL138	High temp. alarm
AL139	Low temp. alarm
AL140	Temp.delta alarm
AL141	EVI alarm:Param.range error
AL142	EVI alarm:Low superheat
AL143	EVI alarm:LOP
AL144	EVI alarm:MOP
AL145	EVI alarm:High condens.temp.
AL146	EVI alarm:Low suction temp.
AL147	EVI alarm:Motor error
AL148	EVI alarm:Self Tuning
AL149	EVI alarm:Emergency closing
AL150	EVI alarm:ServicePosit% err
AL151	EVI alarm:ValveID pin error

3、 Other problem and repairing

No	Error	Possible reason	Method
1	Heat pump doesn't run	<ol style="list-style-type: none"> 1. Power supply cable is loose 2. The fuse of power supply is fused. 	<ol style="list-style-type: none"> 1. Cut off the power supply to check and repair. 2. Change the fuse.
2	Heating capacity is too small	<ol style="list-style-type: none"> 1. Refrigerant is not enough 2. Water system insulating is not good 3. Air heat exchanger is dirty 4. Water heat exchanger scaled 	<ol style="list-style-type: none"> 1. Check leakage and repair and refill gas 2. Improve the insulation 3. Clean air heat exchanger 4. Clean water heat exchanger
3	Compressor doesn't run	<ol style="list-style-type: none"> 1. Power supply has error 2. Cable connecting is loose 3. Compressor is overheat 	<ol style="list-style-type: none"> 1. Check reason and solve 2. Check loose and repair 3. Check reason and repair
4	Compressor noise is loud	<ol style="list-style-type: none"> 1. Expansion valve damaged lead to liquid entering compressor 2. The internal parts of compressor damaged 3. Compressor lack of oil 	<ol style="list-style-type: none"> 1. Change expansion valve 2. Change compressor 3. Compensate oil for compressor
5	Fan motor doesn't run	<ol style="list-style-type: none"> 1. Fan blade fixing screw is loose 2. Fan motor damaged 3. Fan motor capacitance damaged 	<ol style="list-style-type: none"> 1. Tight the screw 2. Change fan motor 3. Change the capacitance
6	Compressor run, but not heat	<ol style="list-style-type: none"> 1. There is not refrigerant at all 2. Compressor damaged 	<ol style="list-style-type: none"> 1. Check leakage and repair 2. Change compressor

Items of warranty:

1. Warranty terms: _____; Within warranty, any problem because of quality, please contact us for support.
2. When repair needed, please show the warranty card and invoice of order or other proof.
3. We don't afford the problem that is caused by re-fitment or adding other function by user.
4. Warranty card and invoice or other purchasing proof will be invalid if alerted.
5. Please keep the warranty card and invoice or other purchasing proofs well, we will need these for service purpose.
6. We will not provide free warranty for below conditions:
 - (1) without proof;
 - (2) errors caused by re-fitment or not correct operating;
 - (3) damage caused by not professional people operating;
 - (4) faulty by moving or falling;
 - (5) faulty caused by natural disaster.

CERTIFICATE

Product Model: _____

Bar code: _____
